

O.E.M.

| OEM | Part Number / Ref OEM | Part Number / Ref OEM | Ref.FAE | Catalogue Catálogo | English/Ingles | Español/Spanish | French/Francés | German/Alemán | Italian/Italiano |
|----------------|-----------------------|-----------------------|---------|--------------------|-------------------------------|---------------------------------|--|-----------------------------|---------------------------------|
| HONDA | 37830-R3L-BG00 | 37830R3LBG000 | 15174 | CGM | Manifold absolute pressure se | Sensor de presión absoluta | Capteur de pression | Ladedruck Sensor | Sensori pressione assoluta |
| HONDA | 37830-R3L-G01 | 37830R3LG01 | 15174 | CGM | Manifold absolute pressure se | Sensor de presión absoluta | Capteur de pression | Ladedruck Sensor | Sensori pressione assoluta |
| HONDA | 37830-R3L-G010 | 37830R3LG010 | 15174 | CGM | Manifold absolute pressure se | Sensor de presión absoluta | Capteur de pression | Ladedruck Sensor | Sensori pressione assoluta |
| HONDA | 37830-RBD-E01 | 37830RBD01 | 15174 | CGM | Manifold absolute pressure se | Sensor de presión absoluta | Capteur de pression | Ladedruck Sensor | Sensori pressione assoluta |
| HONDA | 37830-RBD-E01 4 | 37830RBD014 | 15174 | CGM | Manifold absolute pressure se | Sensor de presión absoluta | Capteur de pression | Ladedruck Sensor | Sensori pressione assoluta |
| CITROËN | 16.099.426.80 | 1609942680 | 16120 | CGM | Exhaust pressure sensor | Sensor presión gas de escape | Capteur pression des gaz échappement | Abgasdruck Sensor | Sensore pressione gas scarico |
| MAZDA | SH01-18-2B2 | SH01182B2 | 16120 | CGM | Exhaust pressure sensor | Sensor presión gas de escape | Capteur pression des gaz échappement | Abgasdruck Sensor | Sensore pressione gas scarico |
| MINI | 1865A210 | 1865A210 | 16120 | CGM | Exhaust pressure sensor | Sensor presión gas de escape | Capteur pression des gaz échappement | Abgasdruck Sensor | Sensore pressione gas scarico |
| PEUGEOT | 16 099 426 80 | 1609942680 | 16120 | CGM | Exhaust pressure sensor | Sensor presión gas de escape | Capteur pression des gaz échappement | Abgasdruck Sensor | Sensore pressione gas scarico |
| SUBARU | 22627-AA500 | 22627AA500 | 16120 | CGM | Exhaust pressure sensor | Sensor presión gas de escape | Capteur pression des gaz échappement | Abgasdruck Sensor | Sensore pressione gas scarico |
| CHEVROLET | 25036751 | 25036751 | 33231 | CGM | Intake air temp. sensor | Sensor temp. aire admisión | Capteur temp. d'admission d'air | Ansauglufttemperatur Sensor | Sensore temp. presa d'aria |
| GENERAL MOTORS | 25036751 | 25036751 | 33231 | CGM | Intake air temp. sensor | Sensor temp. aire admisión | Capteur temp. d'admission d'air | Ansauglufttemperatur Sensor | Sensore temp. presa d'aria |
| ISUZU | 8-25036-751-0 | 8250367510 | 33231 | CGM | Intake air temp. sensor | Sensor temp. aire admisión | Capteur temp. d'admission d'air | Ansauglufttemperatur Sensor | Sensore temp. presa d'aria |
| VOLKSWAGEN | 8658133 | 8658133 | 75141 | COX6 | Oxygen sensor | Sonda Lambda | Sonde lambda | Lambdasonde | Sonda Lambda |
| VOLKSWAGEN | 8670279 | 8670279 | 75141 | COX6 | Oxygen sensor | Sonda Lambda | Sonde lambda | Lambdasonde | Sonda Lambda |
| VOLVO | 8658133 | 8658133 | 75141 | COX6 | Oxygen sensor | Sonda Lambda | Sonde lambda | Lambdasonde | Sonda Lambda |
| VOLVO | 8670279 | 8670279 | 75141 | COX6 | Oxygen sensor | Sonda Lambda | Sonde lambda | Lambdasonde | Sonda Lambda |
| FORD | 1759361 | 1759361 | 77673 | COX | Oxygen sensor | Sonda Lambda | Sonde lambda | Lambdasonde | Sonda Lambda |
| FORD | CM5A-9G444-AA | CM5A9G444AA | 77673 | COX | Oxygen sensor | Sonda Lambda | Sonde lambda | Lambdasonde | Sonda Lambda |
| HYUNDAI | 39210-03000 | 3921003000 | 77674 | COX | Oxygen sensor | Sonda Lambda | Sonde lambda | Lambdasonde | Sonda Lambda |
| HYUNDAI | 39210-2B040 | 392102B040 | 77674 | COX | Oxygen sensor | Sonda Lambda | Sonde lambda | Lambdasonde | Sonda Lambda |
| KIA | 39210 2B040 | 392102B040 | 77674 | COX | Oxygen sensor | Sonda Lambda | Sonde lambda | Lambdasonde | Sonda Lambda |
| CHRYSLER | 05269868 AB | 05269868AB | 77676 | COX | Oxygen sensor | Sonda Lambda | Sonde lambda | Lambdasonde | Sonda Lambda |
| CHRYSLER | 5269868 AB | 5269868AB | 77676 | COX | Oxygen sensor | Sonda Lambda | Sonde lambda | Lambdasonde | Sonda Lambda |
| DODGE | 05269868AB | 05269868AB | 77676 | COX | Oxygen sensor | Sonda Lambda | Sonde lambda | Lambdasonde | Sonda Lambda |
| DODGE | 5269868AB | 5269868AB | 77676 | COX | Oxygen sensor | Sonda Lambda | Sonde lambda | Lambdasonde | Sonda Lambda |
| CHEVROLET | 96394003 | 96394003 | 77678 | COX | Oxygen sensor | Sonda Lambda | Sonde lambda | Lambdasonde | Sonda Lambda |
| CHEVROLET | 96394004 | 96394004 | 77678 | COX | Oxygen sensor | Sonda Lambda | Sonde lambda | Lambdasonde | Sonda Lambda |
| DAEWOO | 96394004 | 96394004 | 77678 | COX | Oxygen sensor | Sonda Lambda | Sonde lambda | Lambdasonde | Sonda Lambda |
| GENERAL MOTORS | 96394004 | 96394004 | 77678 | COX | Oxygen sensor | Sonda Lambda | Sonde lambda | Lambdasonde | Sonda Lambda |
| SUZUKI | 18213-84Z01 | 1821384Z01 | 77678 | COX | Oxygen sensor | Sonda Lambda | Sonde lambda | Lambdasonde | Sonda Lambda |
| HYUNDAI | 39210-04010 | 3921004010 | 77679 | COX | Oxygen sensor | Sonda Lambda | Sonde lambda | Lambdasonde | Sonda Lambda |
| KIA | 39210 04010 | 3921004010 | 77679 | COX | Oxygen sensor | Sonda Lambda | Sonde lambda | Lambdasonde | Sonda Lambda |
| FORD | 1516502 | 1516502 | 78268 | CABS | Wheel speed sensor - ABS | Sensor revoluciones rueda - ABS | Capteur vitesse rotation de roue - ABS | Raddrehzahlsensor - ABS | Sensore di velocità ruota - ABS |
| FORD | 1528034 | 1528034 | 78268 | CABS | Wheel speed sensor - ABS | Sensor revoluciones rueda - ABS | Capteur vitesse rotation de roue - ABS | Raddrehzahlsensor - ABS | Sensore di velocità ruota - ABS |
| FORD | 1761079 | 1761079 | 78268 | CABS | Wheel speed sensor - ABS | Sensor revoluciones rueda - ABS | Capteur vitesse rotation de roue - ABS | Raddrehzahlsensor - ABS | Sensore di velocità ruota - ABS |
| FORD | 1766843 | 1766843 | 78268 | CABS | Wheel speed sensor - ABS | Sensor revoluciones rueda - ABS | Capteur vitesse rotation de roue - ABS | Raddrehzahlsensor - ABS | Sensore di velocità ruota - ABS |
| FORD | 713F-9350-AAB | 713F9350AAB | 78268 | CABS | Wheel speed sensor - ABS | Sensor revoluciones rueda - ABS | Capteur vitesse rotation de roue - ABS | Raddrehzahlsensor - ABS | Sensore di velocità ruota - ABS |
| FORD | 8V51-2C204-AB | 8V512C204AB | 78268 | CABS | Wheel speed sensor - ABS | Sensor revoluciones rueda - ABS | Capteur vitesse rotation de roue - ABS | Raddrehzahlsensor - ABS | Sensore di velocità ruota - ABS |
| FORD | 8V51-2C204-AC | 8V512C204AC | 78268 | CABS | Wheel speed sensor - ABS | Sensor revoluciones rueda - ABS | Capteur vitesse rotation de roue - ABS | Raddrehzahlsensor - ABS | Sensore di velocità ruota - ABS |
| FORD | 8V51-2C204-AD | 8V512C204AD | 78268 | CABS | Wheel speed sensor - ABS | Sensor revoluciones rueda - ABS | Capteur vitesse rotation de roue - ABS | Raddrehzahlsensor - ABS | Sensore di velocità ruota - ABS |
| FORD | 8V51-2C204-AE | 8V512C204AE | 78268 | CABS | Wheel speed sensor - ABS | Sensor revoluciones rueda - ABS | Capteur vitesse rotation de roue - ABS | Raddrehzahlsensor - ABS | Sensore di velocità ruota - ABS |

O.E.M.

| OEM | Part Number / Ref OEM | Part Number / Ref OEM | Ref.FAE | Catalogue Catálogo | English/Ingles | Español/Spanish | French/Francés | German/Alemán | Italian/Italiano |
|------------|-----------------------|-----------------------|--------------|--------------------|--------------------------|---------------------------------|--|-----------------------------|---------------------------------|
| FORD | 8V51-2C204-AF | 8V512C204AF | 78268 | CABS | Wheel speed sensor - ABS | Sensor revoluciones rueda - ABS | Capteur vitesse rotation de roue - ABS | Raddrehzahlsensor - ABS | Sensore di velocità ruota - ABS |
| FORD | 8V51-2C204-BA | 8V512C204BA | 78268 | CABS | Wheel speed sensor - ABS | Sensor revoluciones rueda - ABS | Capteur vitesse rotation de roue - ABS | Raddrehzahlsensor - ABS | Sensore di velocità ruota - ABS |
| RENAULT | 47 91 000 01N | 479100001N | 78273 | CABS3 | Wheel speed sensor - ABS | Sensor revoluciones rueda - ABS | Capteur vitesse rotation de roue - ABS | Raddrehzahlsensor - ABS | Sensore di velocità ruota - ABS |
| FIAT | 46837685 | 46837685 | 78395 | CABS | Wheel speed sensor - ABS | Sensor revoluciones rueda - ABS | Capteur vitesse rotation de roue - ABS | Raddrehzahlsensor - ABS | Sensore di velocità ruota - ABS |
| ALFA ROMEO | 46839673 | 46839673 | 78433 | CABS | Wheel speed sensor - ABS | Sensor revoluciones rueda - ABS | Capteur vitesse rotation de roue - ABS | Raddrehzahlsensor - ABS | Sensore di velocità ruota - ABS |
| ALFA ROMEO | 51791156 | 51791156 | 78433 | CABS | Wheel speed sensor - ABS | Sensor revoluciones rueda - ABS | Capteur vitesse rotation de roue - ABS | Raddrehzahlsensor - ABS | Sensore di velocità ruota - ABS |
| FIAT | 46839673 | 46839673 | 78433 | CABS | Wheel speed sensor - ABS | Sensor revoluciones rueda - ABS | Capteur vitesse rotation de roue - ABS | Raddrehzahlsensor - ABS | Sensore di velocità ruota - ABS |
| FIAT | 51791156 | 51791156 | 78433 | CABS | Wheel speed sensor - ABS | Sensor revoluciones rueda - ABS | Capteur vitesse rotation de roue - ABS | Raddrehzahlsensor - ABS | Sensore di velocità ruota - ABS |
| RENAULT | 82 00 735 314 | 8200735314 | 78437 | CABS | Wheel speed sensor - ABS | Sensor revoluciones rueda - ABS | Capteur vitesse rotation de roue - ABS | Raddrehzahlsensor - ABS | Sensore di velocità ruota - ABS |
| VOLVO | 21123875 | 21123875 | 79351 | CGM3 | Camshaft position sensor | Sensor de árbol de levas | Capteur de position d'arbre de came | Nockenwellenpositionssensor | Sensore position albero a camme |
| VOLVO | 8658726 | 8658726 | 79351 | CGM3 | Camshaft position sensor | Sensor de árbol de levas | Capteur de position d'arbre de came | Nockenwellenpositionssensor | Sensore position albero a camme |



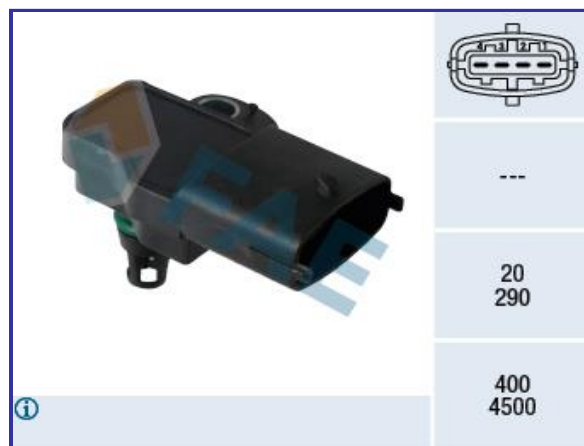

Logistic Information

| Ref.FAE | Status | ESPAÑOL / SPANISH | INGLES / ENGLISH | FRANCS / FRENCH | ALEMAN / GERMAN | ITALIANO / ITALIAN | Intrastat | Weight (Kg) | EAN 13 | L Box (mm) | H Box (mm) | W Box (mm) | Multiple Box | Weight Ind. Box (Kg) | Country of Origin |
|---------|------------------|------------------------------|-----------------------------------|--|-----------------------------|---------------------------------|-----------|-------------|---------------|------------|------------|------------|--------------|----------------------|-------------------|
| 15174 | Available/Activo | Sensor de presión absoluta | Manifold absolute pressure sensor | Capteur de pression | Ladedruck Sensor | Sensori pressione assoluta | 85331000 | 0,0235 | 8435050650127 | 43 | 43 | 70 | 9 | 0,0780 | Spain |
| 16120 | Available/Activo | Sensor presión gas de escape | Exhaust pressure sensor | Capteur pression des gaz échappement | Abgasdruck Sensor | Sensore pressione gas scarico | 90262020 | 0,0220 | 8435050647073 | 65 | 65 | 70 | 4 | 0,0130 | Spain |
| 33231 | Available/Activo | Sensor temp. aire admisión | Intake air temp. sensor | Capteur temp. d'admission d'air | Ansauglufttemperatur Sensor | Sensore temp. presa d'aria | 85331000 | 0,0382 | 8435050650790 | 25 | 26 | 62 | 25 | 0,0036 | Spain |
| 75141 | Available/Activo | Sonda Lambda | Oxygen sensor | Sonde lambda | Lambdasonde | Sonda Lambda | 90271090 | 0,1530 | 8435050653159 | 130 | 40 | 132 | 1 | 0,0272 | Spain |
| 77673 | Available/Activo | Sonda Lambda | Oxygen sensor | Sonde lambda | Lambdasonde | Sonda Lambda | 90271090 | 0,1200 | 8435050655566 | 130 | 40 | 132 | 1 | 0,0272 | Spain |
| 77674 | Available/Activo | Sonda Lambda | Oxygen sensor | Sonde lambda | Lambdasonde | Sonda Lambda | 90271090 | 0,1050 | 8435050655573 | 130 | 40 | 132 | 1 | 0,0272 | Spain |
| 77676 | Available/Activo | Sonda Lambda | Oxygen sensor | Sonde lambda | Lambdasonde | Sonda Lambda | 90271090 | 0,0980 | 8435050655597 | 130 | 40 | 132 | 1 | 0,0272 | Spain |
| 77678 | Available/Activo | Sonda Lambda | Oxygen sensor | Sonde lambda | Lambdasonde | Sonda Lambda | 90271090 | 0,1050 | 8435050655610 | 130 | 40 | 132 | 1 | 0,0272 | Spain |
| 77679 | Available/Activo | Sonda Lambda | Oxygen sensor | Sonde lambda | Lambdasonde | Sonda Lambda | 90271090 | 0,1100 | 8435050655627 | 130 | 40 | 132 | 1 | 0,0272 | Spain |
| 78268 | Available/Activo | Sensor velocidad rueda - ABS | Wheel speed sensor - ABS | Capteur vitesse rotation de roue - ABS | Raddrehzahlsensor - ABS | Sensore di velocità ruota - ABS | 90299000 | 0,0460 | 8435050647707 | 130 | 40 | 132 | 1 | 0,0261 | Spain |
| 78273 | Available/Activo | Sensor velocidad rueda - ABS | Wheel speed sensor - ABS | Capteur vitesse rotation de roue - ABS | Raddrehzahlsensor - ABS | Sensore di velocità ruota - ABS | 90299000 | 0,0426 | 8435050648223 | 130 | 40 | 132 | 1 | 0,0261 | Spain |
| 78395 | Available/Activo | Sensor velocidad rueda - ABS | Wheel speed sensor - ABS | Capteur vitesse rotation de roue - ABS | Raddrehzahlsensor - ABS | Sensore di velocità ruota - ABS | 90299000 | 0,0520 | 8435050652060 | 130 | 40 | 132 | 1 | 0,0261 | Spain |
| 78433 | Available/Activo | Sensor velocidad rueda - ABS | Wheel speed sensor - ABS | Capteur vitesse rotation de roue - ABS | Raddrehzahlsensor - ABS | Sensore di velocità ruota - ABS | 90299000 | 0,0766 | 8435050653326 | 130 | 40 | 132 | 1 | 0,0261 | Spain |
| 78437 | Available/Activo | Sensor velocidad rueda - ABS | Wheel speed sensor - ABS | Capteur vitesse rotation de roue - ABS | Raddrehzahlsensor - ABS | Sensore di velocità ruota - ABS | 90299000 | 0,0474 | 8435050653364 | 130 | 40 | 132 | 1 | 0,0261 | Spain |
| 79351 | Available/Activo | Sensor de árbol de levas | Camshaft position sensor | Capteur de position d'arbre de came | Nockenwellenpositionssensor | Sensore position albero a camme | 90299000 | 0,0260 | 8435050638675 | 67 | 94 | 94 | 22 | 0,0250 | Spain |

| Manifold absolute pressure sensor | Sensor de presión absoluta | Capteur de pression | Ladedruck Sensor |
|-----------------------------------|----------------------------|---------------------|------------------|
|-----------------------------------|----------------------------|---------------------|------------------|



| OEM | Part Number / FAE |
|-------|-------------------|
| HONDA | 37830-R3L-BG0 00 |
| HONDA | 37830-R3L-G01 |
| HONDA | 37830-R3L-G010 |
| HONDA | 37830-RBD-E01 |
| HONDA | 37830-RBD-E01 4 |
| | |
| | |
| | |
| | |

|  | | |  | |  | |  | |
|--|------------------------------|------------------|---|-----|---|---------|---|--|
| HONDA | Accord VII (CL) | 2.2 i-CTDi | N22A1 | 103 | 140 | 01.2004 | 05.2008 | |
| HONDA | Accord VII Tourer (CM) | 2.2 i-CTDi | N22A1 | 103 | 140 | 01.2004 | 05.2008 | |
| HONDA | Accord VIII (CU) | 2.2 i-Dtec | N22B2 | 132 | 180 | 07.2008 | 06.2015 | |
| HONDA | Accord VIII (CU) | 2.2 i-Dtec | N22B1 | 110 | 150 | 07.2008 | 06.2015 | |
| HONDA | Accord VIII Tourer | 2.2 i-Dtec | N22B1 | 110 | 150 | 07.2008 | | |
| HONDA | Accord VIII Tourer | 2.2 i-Dtec | N22B2 | 132 | 180 | 07.2008 | | |
| HONDA | Civic IX (FK) | 2.2 i-Dtec (FK3) | N22B4 | 110 | 150 | 02.2012 | | |
| HONDA | Civic VIII Fastback (FN, FK) | 2.2 CTDi | N22A2 | 103 | 140 | 09.2005 | | |
| HONDA | CR-V II (RD) | 2.2 CTDi | N22A2 | 103 | 140 | 02.2005 | 09.2006 | |
| HONDA | CR-V III (RE) | 2.2 i-CTDi 4WD | N22A2 | 103 | 140 | 01.2007 | | |
| HONDA | CR-V III (RE) | 2.2 i-DTEC 4WD | N22B3 | 110 | 150 | 01.2007 | | |
| HONDA | CR-V IV (RE) | 2.2 i-DTEC AWD | N22B4 | 110 | 150 | 10.2012 | | |
| HONDA | FR-V (BE) | 2.2 i CTDi | N22A1 | 103 | 140 | 07.2005 | | |

Exhaust pressure sensor



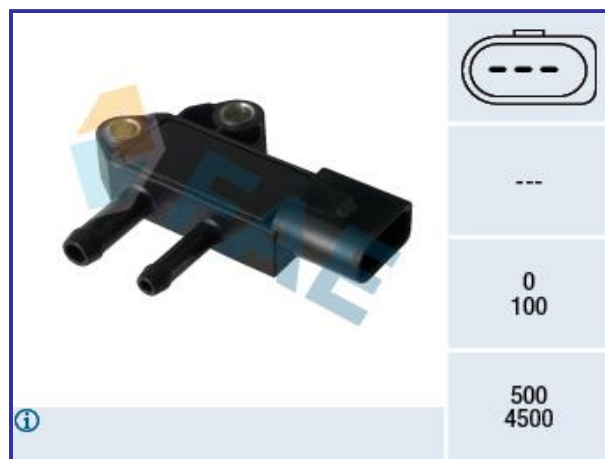

Sensor presión gas de escape

Capteur pression des gaz échappement

Abgasdruck Sensor



| OEM | Part Number / FAE |
|------------|-------------------|
| CITROËN | 16.099.426.80 |
| MAZDA | SH01-18-2B2 |
| MITSUBISHI | 1865A210 |
| PEUGEOT | 16 099 426 80 |
| SUBARU | 22627-AA500 |
| | |
| | |
| | |
| | |
| | |

|  | | |  | |  | |  | |
|--|---------------------------------------|-----------------|---|-----|---|---------|---|--|
| CITROËN | C4 Aircross | 1.8 HDi 150 | 4N13 | 110 | 150 | 04.2012 | | |
| CITROËN | C4 Aircross | 1.8 HDi 150 AWC | 4N13 | 110 | 150 | 04.2012 | | |
| MAZDA | 3 (BM, BN) | 2.2 D | SHY1 | 110 | 150 | 09.2013 | | |
| MAZDA | 3 Sedan (BM, BN) | 2.2 D | SHY1 | 110 | 150 | 09.2013 | | |
| MAZDA | 6 Estate (GJ, GL) | 2.2 D | SHY1 | 110 | 150 | 12.2012 | | |
| MAZDA | 6 Sedan (GJ, GL) | 2.2 D | SHY1 | 110 | 150 | 01.2013 | | |
| MAZDA | CX-5 (KE, GH) | 2.2 D | SHY1 | 110 | 150 | 04.2012 | 02.2017 | |
| MAZDA | CX-5 (KE, GH) | 2.2 D AWD | SHY1 | 110 | 150 | 04.2012 | 02.2017 | |
| MITSUBISHI | ASX (GAW) | 1.8 DI-D | 4N13 | 110 | 150 | 06.2010 | | |
| MITSUBISHI | ASX (GAW) | 1.8 DI-D | 4N13 | 85 | 116 | 06.2010 | | |
| MITSUBISHI | ASX (GAW) | 1.8 DI-D 4WD | 4N13 | 85 | 116 | 06.2010 | | |
| MITSUBISHI | ASX (GAW) | 1.8 DI-D 4WD | 4N13 | 110 | 150 | 06.2010 | | |
| MITSUBISHI | ASX (GAW) | 2.2 Di-D 4WD | 4N14 | 110 | 150 | 04.2013 | | |
| MITSUBISHI | L 200 (KBT, KAT) | 2.5 DI-D | 4D56 (16V)/4D56 HP | 94 | 128 | 04.2010 | 12.2015 | |
| MITSUBISHI | L 200 (KBT, KAT) | 2.5 DI-D 4WD | 4D56 HP | 100 | 136 | 11.2005 | 12.2015 | |
| MITSUBISHI | L 200 (KBT, KAT) | 2.5 DI-D 4WD | 4D56 HP | 131 | 178 | 04.2010 | 12.2015 | |
| MITSUBISHI | Montero IV (Pajero/Shogun) (V8W, V9W) | 3.2 DI-D | 4M41 | 125 | 170 | 02.2007 | | |
| MITSUBISHI | Montero IV (Pajero/Shogun) (V8W, V9W) | 3.2 DI-D | 4M41 | 118 | 160 | 02.2007 | | |

| Exhaust pressure sensor | Sensor presión gas de escape | Capteur pression des gaz échappement | Abgasdruck Sensor | | | | |
|-------------------------|---------------------------------------|--------------------------------------|-------------------|-----|-----|---------|---------|
| mitsubishi | Montero IV (Pajero/Shogun) (V8W, V9W) | 3.2 TD 4WD | 4M41 | 147 | 200 | 01.2009 | |
| mitsubishi | Outlander III (GGW, GFW, ZJ) | 2.2 Di-D (GF6W) | 4N14 | 110 | 150 | 08.2012 | |
| mitsubishi | Outlander III (GGW, GFW, ZJ) | 2.2 Di-D 4WD | 4N14 | 110 | 150 | 08.2012 | |
| PEUGEOT | 4008 | 1.8 Hdi | | 110 | 150 | 05.2012 | |
| PEUGEOT | 4008 | 1.8 HDi AWC | 6HZ (4N13) | 110 | 150 | 05.2012 | |
| SUBARU | Forester (SH) | 2.0 d AWD | EE20Z | 108 | 147 | 09.2008 | 09.2013 |
| SUBARU | Forester (SJ) | 2.0 d AWD | EE20Z | 108 | 147 | 03.2013 | |
| SUBARU | Legacy V (BM) | 2.0 d AWD | EE20Z | 110 | 150 | 09.2009 | 12.2014 |
| SUBARU | Legacy V Station Wagon (BR) | 2.0 d AWD | EE20Z | 110 | 150 | 09.2009 | 12.2014 |
| SUBARU | Outback (BR) | 2.0 d AWD | EE20Z | 110 | 150 | 09.2009 | |
| SUBARU | XV | 2.0 d AWD | EE20Z | 108 | 147 | 03.2012 | |

Intake air temp. sensor

Sensor temp. aire admisión

Capteur temp. d'admission d'air

Ansauglufttemperatur Sensor



| OEM | Part Number / FAE |
|----------------|-------------------|
| CHEVROLET | 25036751 |
| GENERAL MOTORS | 25036751 |
| ISUZU | 8-25036-751-0 |
| | |
| | |
| | |
| | |
| | |
| | |
| | |

| | | | | KW / HP | | 20 | |
|----------|--------------------|--|--|---------|--|------|------|
| ASUNA | SUNFIRE | | | | | 1993 | |
| ASUNA | SUNRUNNER | | | | | 1993 | |
| BUICK | CENTURY | | | | | 1986 | 1992 |
| BUICK | ELECTRA | | | | | 1985 | 1990 |
| BUICK | LESABRE | | | | | 1986 | 1990 |
| BUICK | PARK AVENUE | | | | | 1991 | 1993 |
| BUICK | REATA | | | | | 1988 | 1991 |
| BUICK | REGAL | | | | | 1986 | 1988 |
| BUICK | RIVIERA | | | | | 1987 | 1993 |
| BUICK | SKYHAWK | | | | | 1984 | 1989 |
| BUICK | SKYLARK | | | | | 1985 | 1991 |
| BUICK | SOMERSET | | | | | 1986 | 1987 |
| BUICK | SOMERSET REGAL | | | | | 1985 | |
| CADILLAC | ALLANTE | | | | | 1987 | 1992 |
| CADILLAC | CIMARRON | | | | | 1985 | 1986 |
| CADILLAC | COMMERCIAL CHASSIS | | | | | 1992 | |

| Intake air temp. sensor | Sensor temp. aire admisión | Capteur temp. d'admission d'air | Ansauglufttemperatur Sensor | | | | |
|-------------------------|----------------------------|---------------------------------|-----------------------------|--|--|------|------|
| CADILLAC | DEVILLE | | | | | 1985 | 1995 |
| CADILLAC | ELDORADO | | | | | 1985 | 1993 |
| CADILLAC | FLEETWOOD | | | | | 1985 | 1993 |
| CADILLAC | SEVILLE | | | | | 1985 | 1993 |
| CADILLAC | STS | | | | | 2006 | 2009 |
| CADILLAC | XLR | | | | | 2006 | 2009 |
| CHEVROLET | ASTRO | | | | | 1985 | 1990 |
| CHEVROLET | BERETTA | | | | | 1987 | 1989 |
| CHEVROLET | BLAZER | | | | | 1994 | |
| CHEVROLET | C1500 PICKUP | | | | | 1994 | 1998 |
| CHEVROLET | C1500 SUBURBAN | | | | | 1995 | 1999 |
| CHEVROLET | C2500 PICKUP | | | | | 1994 | 2000 |
| CHEVROLET | C2500 SUBURBAN | | | | | 1994 | 1999 |
| CHEVROLET | C3500 PICKUP | | | | | 1994 | 2002 |
| CHEVROLET | CAMARO | | | | | 1985 | 1992 |
| CHEVROLET | CAVALIER | | | | | 1985 | 1989 |
| CHEVROLET | CELEBRITY | | | | | 1987 | 1990 |
| CHEVROLET | CORSICA | | | | | 1987 | 1989 |
| CHEVROLET | CORVETTE | | | | | 1990 | 1995 |
| CHEVROLET | EXPRESS 2500 | | | | | 1996 | 2002 |
| CHEVROLET | EXPRESS 3500 | | | | | 1996 | 2002 |
| CHEVROLET | G30 | | | | | 1996 | |
| CHEVROLET | K1500 PICKUP | | | | | 1994 | 1998 |
| CHEVROLET | K1500 SUBURBAN | | | | | 1995 | 1999 |
| CHEVROLET | K2500 PICKUP | | | | | 1994 | 2000 |
| CHEVROLET | K2500 SUBURBAN | | | | | 1994 | 1999 |
| CHEVROLET | K3500 PICKUP | | | | | 1994 | 2000 |
| CHEVROLET | LLV | | | | | 1987 | 1995 |
| CHEVROLET | LUMINA | | | | | 1990 | 1992 |
| CHEVROLET | P30 | | | | | 1994 | 1999 |
| CHEVROLET | S10 BLAZER | | | | | 1987 | 1988 |
| CHEVROLET | S10 PICKUP | | | | | 1987 | 1994 |
| CHEVROLET | SPECTRUM | | | | | 1987 | 1988 |
| CHEVROLET | TAHOE | | | | | 1995 | 1999 |
| GEO | SPECTRUM | | | | | 1989 | |



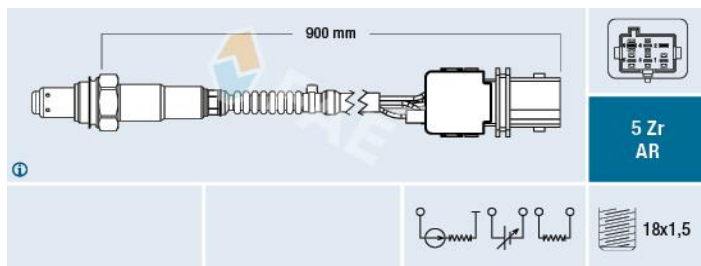

| Intake air temp. sensor | Sensor temp. aire admisión | Capteur temp. d'admission d'air | Ansauglufttemperatur Sensor | | | | |
|-------------------------|----------------------------|---------------------------------|-----------------------------|--|--|------|------|
| GEO | STORM | | | | | 1990 | 1993 |
| GMC | C1500 PICKUP | | | | | 1994 | 1997 |
| GMC | C1500 SUBURBAN | | | | | 1995 | 1999 |
| GMC | C2500 PICKUP | | | | | 1994 | 2000 |
| GMC | C2500 SUBURBAN | | | | | 1994 | 1999 |
| GMC | C3500 PICKUP | | | | | 1994 | 2002 |
| GMC | G3500 | | | | | 1996 | |
| GMC | K1500 PICKUP | | | | | 1994 | 1998 |
| GMC | K1500 SUBURBAN | | | | | 1995 | 1999 |
| GMC | K2500 PICKUP | | | | | 1994 | 2000 |
| GMC | K2500 SUBURBAN | | | | | 1994 | 1999 |
| GMC | K3500 | | | | | 1994 | 2000 |
| GMC | P3500 | | | | | 1994 | 1999 |
| GMC | S15 PICKUP | | | | | 1987 | 1990 |
| GMC | SAFARI | | | | | 1987 | 1990 |
| GMC | SAVANA 2500 | | | | | 1996 | 2002 |
| GMC | SAVANA 3500 | | | | | 1996 | 2002 |
| GMC | SONOMA | | | | | 1991 | 1993 |
| GMC | SYCLONE | | | | | 1991 | |
| GMC | TYPHOON | | | | | 1992 | 1993 |
| GMC | YUKON | | | | | 1994 | 1997 |
| HONDA | PASSPORT | | | | | 1994 | 1997 |
| ISUZU | IMPULSE | | | | | 1989 | 1992 |
| ISUZU | RODEO | | | | | 1993 | 1995 |
| ISUZU | STYLUS | | | | | 1991 | 1993 |
| ISUZU | TROOPER | | | | | 1992 | 1995 |
| OLDSMOBILE | | 98 | | | | 1985 | 1994 |
| OLDSMOBILE | CALAIS | | | | | 1985 | 1987 |
| OLDSMOBILE | CUTLASS CALAIS | | | | | 1988 | 1991 |
| OLDSMOBILE | CUTLASS CIERA | | | | | 1986 | 1992 |
| OLDSMOBILE | CUTLASS SUPREME | | | | | 1987 | 1990 |
| OLDSMOBILE | DELTA 88 | | | | | 1986 | 1991 |
| OLDSMOBILE | FIRENZA | | | | | 1985 | 1988 |
| OLDSMOBILE | TORONADO | | | | | 1986 | 1992 |
| PONTIAC | | 6000 | | | | 1987 | 1991 |

| Intake air temp. sensor | Sensor temp. aire admisión | Capteur temp. d'admission d'air | Ansauglufttemperatur Sensor | | | | |
|-------------------------|----------------------------|---------------------------------|-----------------------------|--|--|------|------|
| PONTIAC | BONNEVILLE | | | | | 1987 | 1991 |
| PONTIAC | FIERO | | | | | 1985 | 1988 |
| PONTIAC | FIREBIRD | | | | | 1985 | 1992 |
| PONTIAC | GRAND AM | | | | | 1985 | 1991 |
| PONTIAC | GRAND PRIX | | | | | 1989 | 1991 |
| PONTIAC | J2000 | | | | | 1985 | |
| PONTIAC | LEMANS | | | | | 1989 | 1990 |
| PONTIAC | SUNBIRD | | | | | 1986 | 1990 |
| PONTIAC | TEMPEST | | | | | 1987 | 1991 |

| | | | |
|---------------|--------------|--------------|-------------|
| Oxygen sensor | Sonda Lambda | Sonde lambda | Lambdasonde |
|---------------|--------------|--------------|-------------|





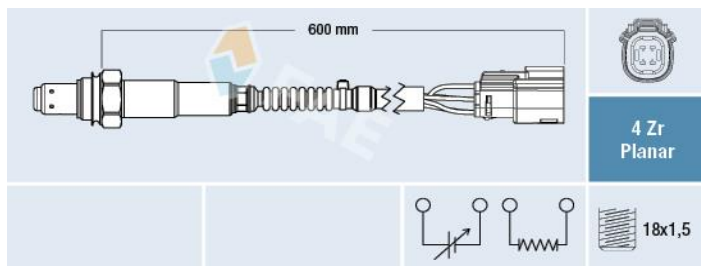

| OEM | Ref. / Part Number |
|------------|--------------------|
| VOLKSWAGEN | 8658133 |
| VOLKSWAGEN | 8670279 |
| VOLVO | 8658133 |
| VOLVO | 8670279 |
| | |
| | |

|  | | |  | |  | |  | |
|--|----------------|--------|---|-----|---|---------|---|--|
| VOLVO | S80 I (TS, XY) | 3.0 T6 | B 6294 T | 200 | 272 | 06.2001 | 07.2006 | |
| VOLVO | XC90 I (275) | T6 | B 6294 T | 200 | 272 | 10.2002 | 12.2006 | |

| Oxygen sensor | Sonda Lambda | Sonde lambda | Lambdasonde |
|---------------|--------------|--------------|-------------|
|---------------|--------------|--------------|-------------|





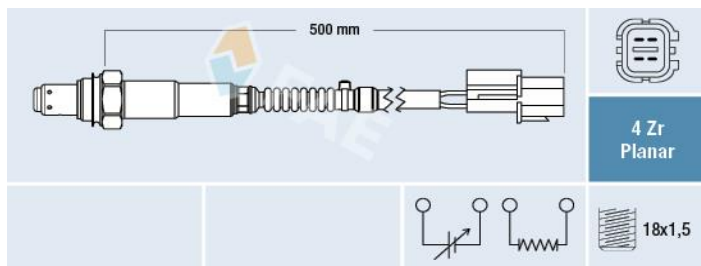

| OEM | Ref. / Part Number |
|------|--------------------|
| FORD | 1759361 |
| FORD | CM5A-9G444-AA |
| | |
| | |
| | |
| | |

|  | | |  | |  | |  | |
|--|-------------------|--------|---|-----|---|---------|---|--|
| FORD | Focus III | 2.0 ST | R9DA | 184 | 250 | 07.2012 | | |
| FORD | Focus III | 2.0 ST | R9DA | 184 | 250 | 07.2012 | | |
| FORD | Focus III Turnier | 2.0 ST | R9DA | 184 | 250 | 07.2012 | | |

| | | | |
|---------------|--------------|--------------|-------------|
| Oxygen sensor | Sonda Lambda | Sonde lambda | Lambdasonde |
|---------------|--------------|--------------|-------------|





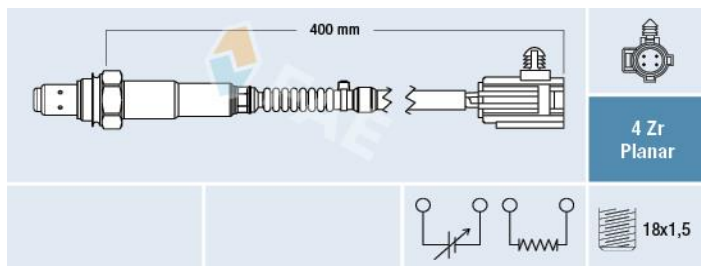

| OEM | Ref. / Part Number |
|---------|--------------------|
| HYUNDAI | 39210-03000 |
| HYUNDAI | 39210-2B040 |
| KIA | 39210 2B040 |
| | |
| | |
| | |

|  | | |  | |  | |  | |
|--|----------|-----|---|----|---|---------|---|--|
| HYUNDAI | i10 (PA) | 1.2 | G4LA | 63 | 86 | 04.2011 | 12.2013 | |
| HYUNDAI | i10 (PA) | 1.2 | G4LA | 57 | 78 | 11.2008 | 12.2011 | |

| Oxygen sensor | Sonda Lambda | Sonde lambda | Lambdasonde |
|---------------|--------------|--------------|-------------|
|---------------|--------------|--------------|-------------|





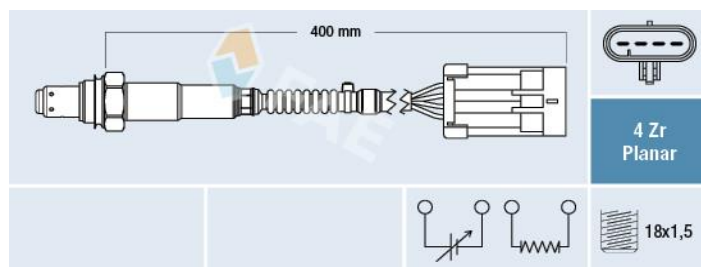

| OEM | Ref. / Part Number |
|----------|--------------------|
| CHRYSLER | 05269868 AB |
| CHRYSLER | 5269868 AB |
| DODGE | 05269868AB |
| DODGE | 5269868AB |
| | |
| | |

|  | | |  | |  | |  | |
|--|---------|---------|---|-----|---|---------|---|--|
| CHRYSLER | Neon II | 1.6 | EJD | 85 | 116 | 11.2001 | 12.2006 | |
| DODGE | Neon II | 2.0 | ECH | 110 | 150 | 10.1999 | 09.2005 | |
| DODGE | Neon II | 2.0 16V | ECB | 98 | 133 | 08.1999 | | |
| DODGE | Neon II | 2.0 16V | ECH | 112 | 152 | 08.1999 | | |
| DODGE | Neon II | 2.0 16V | ECB | 98 | 133 | 08.1999 | | |

| Oxygen sensor | Sonda Lambda | Sonde lambda | Lambdasonde |
|---------------|--------------|--------------|-------------|
|---------------|--------------|--------------|-------------|



| OEM | Ref. / Part Number |
|----------------|--------------------|
| CHEVROLET | 96394003 |
| CHEVROLET | 96394004 |
| DAEWOO | 96394004 |
| GENERAL MOTORS | 96394004 |
| SUZUKI | 18213-84Z01 |



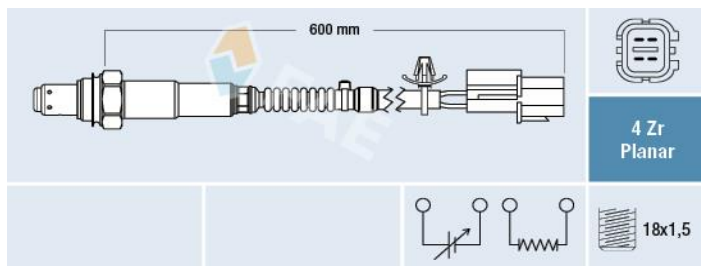

|  | | |  | |  | |  | |
|--|------------------------------------|---------|---|----|---|---------|---|--|
| CHEVROLET | Aveo / Kalos Fastback (T250, T255) | 1.4 16V | F14D3 | 69 | 94 | 06.2006 | 05.2008 | |
| CHEVROLET | Aveo / Kalos Fastback (T250, T255) | 1.4 16V | F14D3 | 69 | 94 | 06.2006 | 05.2008 | |
| CHEVROLET | Aveo / Kalos Fastback (T250, T255) | 1.4 16V | F14D3 | 69 | 94 | 06.2006 | 05.2008 | |
| CHEVROLET | Aveo / Kalos Fastback (T250, T255) | 1.4 16V | F14D3 | 69 | 94 | 06.2006 | 05.2008 | |
| CHEVROLET | Aveo / Kalos Sedán (T200) | 1.4 | F14D3 | 69 | 94 | 05.2003 | 01.2007 | |
| CHEVROLET | Aveo / Kalos Sedán (T200) | 1.4 | F14D3 | 69 | 94 | 05.2003 | 01.2007 | |
| CHEVROLET | Aveo / Kalos Sedán (T200) | 1.4 | F14D3 | 69 | 94 | 05.2003 | 01.2007 | |
| CHEVROLET | Aveo / Kalos Sedán (T200) | 1.4 | F14D3 | 69 | 94 | 05.2003 | 01.2007 | |
| CHEVROLET | Aveo Sedan (T250, T255) | 1.4 | F14D3/L14 | 69 | 94 | 03.2005 | 12.2007 | |
| CHEVROLET | Aveo Sedan (T250, T255) | 1.4 | F14D3/L14 | 69 | 94 | 03.2005 | 12.2007 | |
| CHEVROLET | Evanda | 2.0 | X 20 SED | 96 | 131 | 03.2005 | | |
| CHEVROLET | Evanda | 2.0 | X 20 SED | 96 | 131 | 03.2005 | | |
| CHEVROLET | Kalos | 1.4 | F14S3 | 61 | 83 | 03.2005 | 05.2008 | |
| CHEVROLET | Kalos | 1.4 16V | F14D3 | 69 | 94 | 03.2005 | 05.2008 | |
| CHEVROLET | Kalos | 1.4 16V | F14D3 | 69 | 94 | 03.2005 | 05.2008 | |
| CHEVROLET | Kalos Sedan | 1.4 | F14S3 | 61 | 83 | 03.2005 | | |
| CHEVROLET | Lacetti (J200) | 1.8 | T18SED | 90 | 122 | 03.2005 | | |
| CHEVROLET | Lacetti (J200) | 1.8 | T18SED | 90 | 122 | 03.2005 | | |
| CHEVROLET | Nubira Kombi | 1.8 | T18SED | 90 | 122 | 03.2005 | 12.2009 | |
| CHEVROLET | Nubira Kombi | 1.8 | T18SED | 90 | 122 | 03.2005 | 12.2009 | |
| CHEVROLET | Nubira Sedan | 1.8 | T18SED | 90 | 122 | 03.2005 | 12.2009 | |

| Oxygen sensor | Sonda Lambda | Sonde lambda | Lambdasonde | | | | |
|---------------|--------------------|--------------|--------------|----|-----|---------|---------|
| CHEVROLET | Nubira Sedan | 1.8 | T18SED | 90 | 122 | 03.2005 | 12.2009 |
| CHEVROLET | Sprint Fastback | 1.0 | LP2 | 40 | 54 | 03.1989 | 12.1992 |
| CHEVROLET | Sprint Fastback | 1.0 | LP2 | 40 | 54 | 03.1989 | 12.1992 |
| CHEVROLET | Sprint Fastback | 1.0 | LP2 | 40 | 54 | 03.1989 | 12.1992 |
| CHEVROLET | Sprint Fastback | 1.0 | LP2 | 40 | 54 | 03.1989 | 12.1992 |
| DAEWOO | Evanda (KLAL) | 2.0 | L88/X 20 SED | 96 | 131 | 08.2002 | |
| DAEWOO | Kalos (KLAS) | 1.4 16V | F14D3 | 69 | 94 | 04.2003 | |
| DAEWOO | Kalos Sedan (KLAS) | 1.4 | F14D3 | 69 | 94 | 05.2003 | 12.2004 |

| Oxygen sensor | Sonda Lambda | Sonde lambda | Lambdasonde |
|---------------|--------------|--------------|-------------|
|---------------|--------------|--------------|-------------|



| OEM | Ref. / Part Number |
|---------|--------------------|
| HYUNDAI | 39210-04010 |
| KIA | 39210 04010 |
| | |
| | |
| | |

|  | | |  | |  | |  | |
|--|--------------|-----|---|----|---|---------|---|--|
| KIA | Picanto (JA) | 1.0 | G3LA | 49 | 67 | 03.2017 | | |
| KIA | Picanto (TA) | 1.0 | G3LA | 51 | 69 | 05.2011 | | |
| KIA | Picanto (TA) | 1.0 | G3LA | 49 | 67 | 04.2015 | | |

Wheel speed sensor - ABS





Sensor revoluciones rueda - ABS

Capteur vitesse rotation de roue - ABS

Raddrehzahlsensor - ABS



| OEM | Part Number / FAE |
|------|-------------------|
| FORD | 1516502 |
| FORD | 1528034 |
| FORD | 1761079 |
| FORD | 1766843 |
| FORD | 713F-9350-AAB |
| FORD | 8V51-2C204-AB |
| FORD | 8V51-2C204-AC |
| FORD | 8V51-2C204-AD |
| FORD | 8V51-2C204-AE |
| FORD | 8V51-2C204-AF |
| FORD | 8V51-2C204-BA |

|  | | |  | |  | |  | |
|--|------------|--------------|---|----|---|---------|---|--|
| FORD | B-Max | 1.0 EcoBoost | SFJA/SFJB/SFJD/SFJC | 74 | 100 | 10.2012 | | |
| FORD | B-Max | 1.0 EcoBoost | M1JE | 92 | 125 | 10.2012 | | |
| FORD | B-Max | 1.0 EcoBoost | M1JA | 88 | 120 | 10.2012 | | |
| FORD | B-Max | 1.4 | SPJD | 66 | 90 | 10.2012 | | |
| FORD | B-Max | 1.5 TDCi | UGJC | 55 | 75 | 10.2012 | | |
| FORD | B-Max | 1.6 TDCi | T3JB | 70 | 95 | 10.2012 | | |
| FORD | B-Max | 1.6 Ti | IQJA | 77 | 105 | 10.2012 | | |
| FORD | Fiesta Van | 1.25 | SNJA/SNJB | 60 | 82 | 01.2009 | | |
| FORD | Fiesta Van | 1.4 TDCi | F6JB/F6JD | 50 | 68 | 01.2009 | | |
| FORD | Fiesta Van | 1.4 TDCi | KVJA/F6JD | 51 | 70 | 07.2010 | | |
| FORD | Fiesta Van | 1.5 TDCi | UGJC/XUJA/XUJB | 55 | 75 | 10.2012 | | |
| FORD | Fiesta Van | 1.6 TDCi | T3JA/TZJA/TZJB | 70 | 95 | 02.2010 | | |
| FORD | Fiesta Van | 1.6 TDCi | HHJC/HHJD/HHJE | 66 | 90 | 01.2009 | | |
| FORD | Fiesta VI | 1.0 | P4JA/P4JB/P4JC/P4JD | 59 | 80 | 10.2012 | | |
| FORD | Fiesta VI | 1.0 | XMJA/XMJB | 48 | 65 | 01.2013 | | |
| FORD | Fiesta VI | 1.0 EcoBoost | M1JE/M1JH | 92 | 125 | 09.2012 | | |

| Wheel speed sensor - ABS | Sensor revoluciones rueda - ABS | Capteur vitesse rotation de roue - ABS | Raddrehzahlsensor - ABS | | | | |
|--------------------------|---------------------------------|--|-------------------------|-----|-----|---------|--|
| FORD | Fiesta VI | 1.0 EcoBoost | SFJA/SFJB/SFJC/SFJD | 74 | 100 | 01.2013 | |
| FORD | Fiesta VI | 1.0 Sport | YYJA/YYJB | 103 | 140 | 05.2014 | |
| FORD | Fiesta VI | 1.25 | SNJA/SNJB/SNJC/SNJD | 60 | 82 | 06.2008 | |
| FORD | Fiesta VI | 1.25 | STJA/STJB/STJC | 44 | 60 | 06.2008 | |
| FORD | Fiesta VI | 1.4 | SPJA/SPJC | 71 | 97 | 06.2008 | |
| FORD | Fiesta VI | 1.4 LPG | RTJA/RTJB | 71 | 97 | 01.2009 | |
| FORD | Fiesta VI | 1.4 LPG | RTJA/RTJB | 68 | 92 | 01.2009 | |
| FORD | Fiesta VI | 1.4 TDCi | KVJA/F6JD | 51 | 70 | 07.2010 | |
| FORD | Fiesta VI | 1.4 TDCi | F6JB/F6JD | 50 | 68 | 01.2009 | |
| FORD | Fiesta VI | 1.5 TDCi | XVJC/XVJB | 70 | 95 | 05.2015 | |
| FORD | Fiesta VI | 1.5 TDCi | UGJC/XUJA/XUJB | 55 | 75 | 09.2012 | |
| FORD | Fiesta VI | 1.6 ST | JTJA/JTJB | 134 | 182 | 03.2013 | |
| FORD | Fiesta VI | 1.6 ST2000 | JTJC | 147 | 200 | 04.2016 | |
| FORD | Fiesta VI | 1.6 TDCi | HHJC/HHJD/HHJE | 66 | 90 | 06.2008 | |
| FORD | Fiesta VI | 1.6 TDCi | TZJB/TZJA/T3JA | 70 | 95 | 02.2010 | |
| FORD | Fiesta VI | 1.6 TDCi | UBJA/HHJF | 55 | 75 | 06.2008 | |
| FORD | Fiesta VI | 1.6 Ti | HXJB/HXJA | 88 | 120 | 06.2008 | |
| FORD | Fiesta VI | 1.6 Ti | IQJA | 77 | 105 | 09.2012 | |
| FORD | Fiesta VI | 1.6 Ti | U5JA | 99 | 134 | 12.2010 | |
| FORD | Fiesta VI Van | 1.0 EcoBoost | P4JC/P4JD/P4JA/P4JB | 59 | 80 | 10.2012 | |
| FORD | Fiesta VI Van | 1.5 TDCi | XVJC/XVJB | 70 | 95 | 05.2015 | |

Wheel speed sensor - ABS



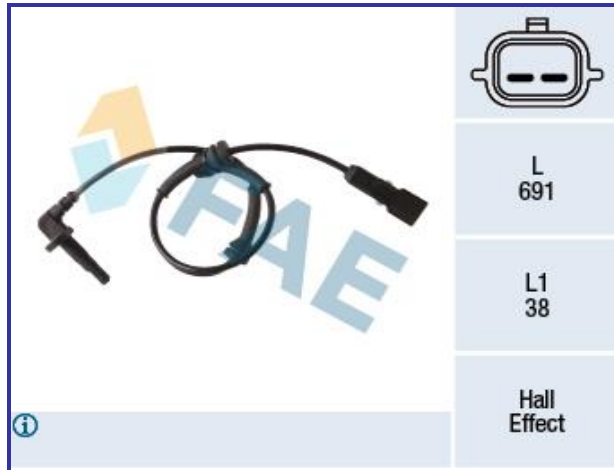

Sensor revoluciones rueda - ABS

Capteur vitesse rotation de roue - ABS

Raddrehzahlsensor - ABS



| OEM | Part Number / FAE |
|---------|-------------------|
| RENAULT | 47 91 000 01N |
| | |
| | |
| | |
| | |
| | |
| | |
| | |
| | |

|  | |  | |  | |  | |
|--|----------------------|---|-------------------------|---|-----|---|--|
| RENAULT | Laguna Coupe (DT0/1) | 1.5 dCi | K9K 846 | 81 | 110 | 03.2012 | |
| RENAULT | Laguna Coupe (DT0/1) | 2.0 16V Turbo | F4Rt 811/F4R 811 | 125 | 170 | 09.2008 | |
| RENAULT | Laguna Coupe (DT0/1) | 2.0 dCi | M9R 809/M9R 815/M9R 800 | 127 | 173 | 09.2008 | |
| RENAULT | Laguna Coupe (DT0/1) | 2.0 dCi | M9R 805/M9R 814/M9R 802 | 110 | 150 | 09.2008 | |
| RENAULT | Laguna Coupe (DT0/1) | 2.0 dCi GT | M9R 820/M9R 816 | 131 | 178 | 09.2008 | |
| RENAULT | Laguna Coupe (DT0/1) | 2.0 GT | F4R 800 | 150 | 204 | 09.2008 | |
| RENAULT | Laguna Coupe (DT0/1) | 3.0 dCi | V9X 791/V9X 891 | 173 | 235 | 09.2008 | |
| RENAULT | Laguna Coupe (DT0/1) | 3.0 dCi | V9X 891 | 177 | 241 | 01.2012 | |
| RENAULT | Laguna Coupe (DT0/1) | 3.5 V6 | V4Y 713 | 175 | 238 | 09.2008 | |
| RENAULT | Laguna III (BT0/1) | 1.5 dCi | K9K 780/K9K 782 | 81 | 110 | 10.2007 | |
| RENAULT | Laguna III (BT0/1) | 1.6 16V | K4M 824 | 81 | 110 | 10.2007 | |
| RENAULT | Laguna III (BT0/1) | 2.0 16V | M4R 704 | 103 | 140 | 10.2007 | |
| RENAULT | Laguna III (BT0/1) | 2.0 16V Hi-Flex | M4R 726 | 103 | 140 | 10.2007 | |
| RENAULT | Laguna III (BT0/1) | 2.0 16V Turbo | F4R 811 | 125 | 170 | 10.2007 | |
| RENAULT | Laguna III (BT0/1) | 2.0 dCi | M9R 744/M9R 802/M9R 742 | 96 | 131 | 10.2007 | |
| RENAULT | Laguna III (BT0/1) | 2.0 dCi | M9R 805/M9R 814/M9R 802 | 110 | 150 | 10.2007 | |

| Wheel speed sensor - ABS | Sensor revoluciones rueda - ABS | Capteur vitesse rotation de roue - ABS | Raddrehzahlsensor - ABS | | | | |
|--------------------------|---------------------------------|--|-------------------------|-----|-----|---------|--|
| RENAULT | Laguna III (BT0/1) | 2.0 dCi | M9R 809/M9R 815/M9R 800 | 127 | 173 | 01.2008 | |
| RENAULT | Laguna III (BT0/1) | 2.0 dCi GT | M9R 816 | 131 | 178 | 03.2008 | |
| RENAULT | Laguna III (BT0/1) | 2.0 GT | F4R 800 | 150 | 204 | 03.2008 | |
| RENAULT | Laguna III (BT0/1) | 3.0 dCi | V9X 791/V9X 891 | 173 | 235 | 09.2008 | |
| RENAULT | Laguna III (BT0/1) | 3.5 V6 | V4Y 713 | 175 | 238 | 04.2008 | |
| RENAULT | Laguna III Grandtour (KT0/1) | 1.5 dCi | K9K 780/K9K 782 | 81 | 110 | 10.2007 | |
| RENAULT | Laguna III Grandtour (KT0/1) | 1.6 16V | K4M 824 | 81 | 110 | 10.2007 | |
| RENAULT | Laguna III Grandtour (KT0/1) | 2.0 16V | M4R 704 | 103 | 140 | 10.2007 | |
| RENAULT | Laguna III Grandtour (KT0/1) | 2.0 16V Hi-Flex | M4R 704/M4R 726 | 103 | 140 | 10.2007 | |
| RENAULT | Laguna III Grandtour (KT0/1) | 2.0 16V Turbo | F4R 811 | 125 | 170 | 10.2007 | |
| RENAULT | Laguna III Grandtour (KT0/1) | 2.0 dCi | M9R 809/M9R 815/M9R 800 | 127 | 173 | 01.2008 | |
| RENAULT | Laguna III Grandtour (KT0/1) | 2.0 dCi | M9R 805/M9R 814/M9R 802 | 110 | 150 | 10.2007 | |
| RENAULT | Laguna III Grandtour (KT0/1) | 2.0 dCi | M9R 744/M9R 802/M9R 742 | 96 | 131 | 10.2007 | |
| RENAULT | Laguna III Grandtour (KT0/1) | 2.0 dCi GT | M9R 820/M9R 816 | 131 | 178 | 03.2008 | |
| RENAULT | Laguna III Grandtour (KT0/1) | 2.0 GT | F4R 800 | 150 | 204 | 03.2008 | |
| RENAULT | Laguna III Grandtour (KT0/1) | 3.0 dCi | V9X 791/V9X 891 | 173 | 235 | 09.2008 | |
| RENAULT | Laguna III Grandtour (KT0/1) | 3.5 V6 | V4Y 713 | 175 | 238 | 04.2008 | |

Wheel speed sensor - ABS



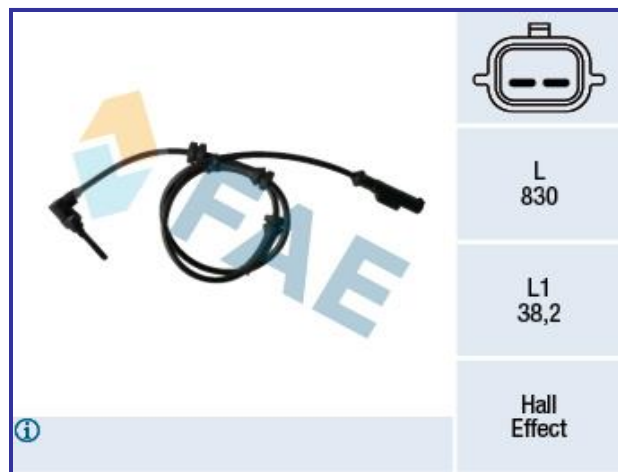

Sensor revoluciones rueda - ABS

Capteur vitesse rotation de roue - ABS

Raddrehzahlsensor - ABS



| OEM | Part Number / FAE |
|------|-------------------|
| FIAT | 46837685 |
| | |
| | |
| | |
| | |
| | |
| | |
| | |
| | |
| | |

|  | | |  | |  | |  | |
|--|-------------------|-------------------|---|----|---|---------|---|--|
| FIAT | Punto (188) | 1.2 16V 80 | 188 A5.000 | 59 | 80 | 09.1999 | 12.2006 | |
| FIAT | Punto (188) | 1.2 60 | 188 A4.000 | 44 | 60 | 09.1999 | 12.2010 | |
| FIAT | Punto (188) | 1.2 Bifuel | 188 A4.000 | 44 | 60 | 08.2007 | 03.2012 | |
| FIAT | Punto (188) | 1.2 Natural Power | 188 A4.000 | 44 | 60 | 09.2003 | 03.2012 | |
| FIAT | Punto (188) | 1.3 JTD 16V | 188 A9.000 | 51 | 70 | 06.2003 | 03.2012 | |
| FIAT | Punto (188) | 1.4 | 199 A6.000 | 71 | 97 | 11.2005 | 03.2012 | |
| FIAT | Punto (188) | 1.4 | 843 A1.000 | 70 | 95 | 09.2003 | 03.2012 | |
| FIAT | Punto (188) | 1.8 130 HGT | 183 A1.000/188 A6.000 | 96 | 130 | 09.1999 | 03.2012 | |
| FIAT | Punto (188) | 1.9 JTD | 188 A7.000 | 63 | 86 | 10.2001 | 03.2012 | |
| FIAT | Punto (188) | 1.9 JTD | 188 B2.000 | 74 | 101 | 06.2003 | 03.2012 | |
| FIAT | Punto Van (188) | 1.3 D Multijet | 188 A9.000 | 55 | 75 | 02.2005 | 10.2009 | |
| FIAT | Punto Van (188AX) | 1.2 60 | 188 A4.000 | 44 | 60 | 02.2000 | 10.2009 | |
| FIAT | Punto Van (188AX) | 1.3 JTD | 188 A9.000 | 51 | 69 | 06.2003 | 10.2005 | |
| FIAT | Punto Van (188AX) | 1.9 JTD | 188 A7.000 | 63 | 86 | 02.2000 | 10.2009 | |

Wheel speed sensor - ABS

Sensor revoluciones rueda - ABS

Capteur vitesse rotation de roue - ABS

Raddrehzahlsensor - ABS



| OEM | Part Number / FAE |
|------------|-------------------|
| ALFA ROMEO | 46839673 |
| ALFA ROMEO | 51791156 |
| FIAT | 46839673 |
| FIAT | 51791156 |
| | |
| | |
| | |
| | |
| | |

| ALFA ROMEO | 147 (937) | 1.6 16V T.SPARK | AR 32104 | 88 | 120 | 01.2001 | 03.2010 |
|------------|-----------|---------------------|-----------------------|-----|-----|---------|---------|
| ALFA ROMEO | 147 (937) | 1.6 16V T.SPARK ECO | AR 37203 | 77 | 105 | 01.2001 | 03.2010 |
| ALFA ROMEO | 147 (937) | 1.9 JTD | 937 A2.000 | 85 | 115 | 04.2001 | 03.2010 |
| ALFA ROMEO | 147 (937) | 1.9 JTD | 182 B9.000 | 74 | 101 | 06.2003 | 03.2010 |
| ALFA ROMEO | 147 (937) | 1.9 JTD 16V | 937 A4.000 | 93 | 126 | 09.2003 | 09.2004 |
| ALFA ROMEO | 147 (937) | 1.9 JTD 16V | 192 B1.000 | 100 | 136 | 10.2004 | 03.2010 |
| ALFA ROMEO | 147 (937) | 1.9 JTD 16V | 192 A5.000 | 103 | 140 | 11.2002 | 03.2010 |
| ALFA ROMEO | 147 (937) | 1.9 JTDM | 939 A7.000 | 85 | 115 | 10.2004 | 03.2010 |
| ALFA ROMEO | 147 (937) | 1.9 JTDM 16V | 937 A6.000 | 125 | 170 | 06.2008 | 03.2010 |
| ALFA ROMEO | 147 (937) | 1.9 JTDM 16V | 937 A5.000 | 110 | 150 | 09.2004 | 03.2010 |
| ALFA ROMEO | 147 (937) | 1.9 JTDM 8V | 937 A2.000/937 A3.000 | 88 | 120 | 07.2005 | 03.2010 |
| ALFA ROMEO | 147 (937) | 2.0 16V T.SPARK | AR 32310 | 110 | 150 | 01.2001 | 03.2010 |
| ALFA ROMEO | 147 (937) | 3.2 GTA | 932 A.000 | 184 | 250 | 02.2003 | 03.2010 |

Wheel speed sensor - ABS

Sensor revoluciones rueda - ABS

Capteur vitesse rotation de roue - ABS

Raddrehzahlsensor - ABS

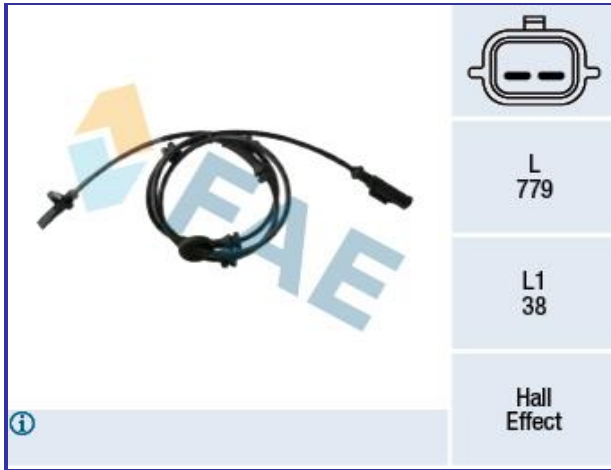

| OEM | Part Number / FAE |
|---------|-------------------|
| RENAULT | 82 00 735 314 |
| | |
| | |
| | |
| | |
| | |
| | |
| | |
| | |

| RENAULT | Master III Bus (JV) | 2.3 dCi 100 FWD | M9T 670/M9T 672/M9T 870/M9T 676 | 74 | 101 | 02.2011 | | | |
|---------|---------------------------------|-------------------|---|-----|-----|---------|--|--|--|
| RENAULT | Master III Bus (JV) | 2.3 dCi 110 FWD | M9T 870, M9T 890 | 81 | 110 | 09.2014 | | | |
| RENAULT | Master III Bus (JV) | 2.3 dCi 125 FWD | M9T 670/M9T 672/M9T 870/M9T 676 | 92 | 125 | 02.2011 | | | |
| RENAULT | Master III Bus (JV) | 2.3 dCi 135 FWD | M9T 700/M9T 702 | 100 | 136 | 07.2014 | | | |
| RENAULT | Master III Bus (JV) | 2.3 dCi 150 | M9T 880 | 110 | 150 | 10.2012 | | | |
| RENAULT | Master III Bus (JV) | 2.3 dCi 165 FWD | M9T 700/M9T 702 | 120 | 163 | 07.2014 | | | |
| RENAULT | Master III Bus (JV) | 2.3 dCi 170 FWD | M9T 706 | 125 | 170 | 07.2015 | | | |
| RENAULT | Master III Bus (JV) | 2.3 dCi FWD | M9T 680 | 107 | 146 | 02.2011 | | | |
| RENAULT | Master III Chassis (EV, HV, UV) | 2.3 dCi [RWD] | M9T 696/M9T 698/M9T 896/M9T 694 | 107 | 146 | 02.2010 | | | |
| RENAULT | Master III Chassis (EV, HV, UV) | 2.3 dCi [RWD] | M9T 670/M9T 690/M9T 692/M9T 870/M9T 890 | 74 | 101 | 02.2010 | | | |
| RENAULT | Master III Chassis (EV, HV, UV) | 2.3 dCi [RWD] | M9T 880/M9T 898 | 110 | 150 | 03.2013 | | | |
| RENAULT | Master III Chassis (EV, HV, UV) | 2.3 dCi [RWD] | M9T 890/M9T 698/M9T 692/M9T 686/M9T 870/M9T 690 | 92 | 125 | 02.2010 | | | |
| RENAULT | Master III Chassis (EV, HV, UV) | 2.3 dCi 110 FWD | M9T 870 | 81 | 110 | 09.2014 | | | |
| RENAULT | Master III Chassis (EV, HV, UV) | 2.3 dCi 130 FWD | | 96 | 130 | 03.2012 | | | |
| RENAULT | Master III Chassis (EV, HV, UV) | 2.3 dCi 130 RWD | | 96 | 130 | 07.2016 | | | |
| RENAULT | Master III Chassis (EV, HV, UV) | 2.3 dCi 135 [RWD] | M9T 700/M9T 702 | 100 | 136 | 07.2014 | | | |
| RENAULT | Master III Chassis (EV, HV, UV) | 2.3 dCi 135 FWD | M9T 702 | 100 | 136 | 07.2014 | | | |

| Wheel speed sensor - ABS | Sensor revoluciones rueda - ABS | Capteur vitesse rotation de roue - ABS | Raddrehzahlsensor - ABS | | | | |
|--------------------------|---------------------------------|--|---|-----|-----|---------|--|
| RENAULT | Master III Chassis (EV, HV, UV) | 2.3 dCi 165 [RWD] | M9T 700/M9T 702 | 120 | 163 | 07.2014 | |
| RENAULT | Master III Chassis (EV, HV, UV) | 2.3 dCi 165 FWD | M9T 700/M9T 702 | 120 | 163 | 07.2014 | |
| RENAULT | Master III Chassis (EV, HV, UV) | 2.3 dCi 170 FWD | | 125 | 170 | 06.2016 | |
| RENAULT | Master III Chassis (EV, HV, UV) | 2.3 dCi FWD | M9T 890/M9T 670/M9T 672/M9T 870/M9T 676 | 74 | 101 | 02.2010 | |
| RENAULT | Master III Chassis (EV, HV, UV) | 2.3 dCi FWD | M9T 880/M9T 898 | 110 | 150 | 03.2013 | |
| RENAULT | Master III Chassis (EV, HV, UV) | 2.3 dCi FWD | M9T 696/M9T 890/M9T 698/M9T 896/M9T 670/M9T 672/M9T 676 | 92 | 125 | 02.2010 | |
| RENAULT | Master III Chassis (EV, HV, UV) | 2.3 dCi FWD | M9T 698/M9T 680/M9T 678/M9T 896 | 107 | 146 | 02.2010 | |
| RENAULT | Master III Van (FV) | 2.3 dCi [RWD] | M9T 696/M9T 890/M9T 698/M9T 896/M9T 692/M9T 686/M9T 672 | 92 | 125 | 02.2010 | |
| RENAULT | Master III Van (FV) | 2.3 dCi [RWD] | M9T 890/M9T 692/M9T 870/M9T 690 | 74 | 101 | 02.2010 | |
| RENAULT | Master III Van (FV) | 2.3 dCi [RWD] | M9T 694/M9T 696/M9T 698/M9T 880/M9T 898 | 110 | 150 | 03.2013 | |
| RENAULT | Master III Van (FV) | 2.3 dCi [RWD] | M9T 698/M9T 896/M9T 694 | 107 | 146 | 02.2010 | |
| RENAULT | Master III Van (FV) | 2.3 dCi 110 FWD | M9T 870 | 81 | 110 | 09.2014 | |
| RENAULT | Master III Van (FV) | 2.3 dCi 130 FWD | M9T 692 | 96 | 130 | 06.2016 | |
| RENAULT | Master III Van (FV) | 2.3 dCi 130 RWD | | 96 | 130 | 03.2012 | |
| RENAULT | Master III Van (FV) | 2.3 dCi 135 [RWD] | M9T 700/M9T 702 | 100 | 136 | 07.2014 | |
| RENAULT | Master III Van (FV) | 2.3 dCi 135 FWD | M9T 702 | 100 | 136 | 07.2014 | |
| RENAULT | Master III Van (FV) | 2.3 dCi 165 [RWD] | M9T 700/M9T 702 | 120 | 163 | 07.2014 | |
| RENAULT | Master III Van (FV) | 2.3 dCi 165 FWD | M9T 702 | 120 | 163 | 07.2014 | |
| RENAULT | Master III Van (FV) | 2.3 dCi 170 FWD | M9T 706 | 125 | 170 | 07.2015 | |
| RENAULT | Master III Van (FV) | 2.3 dCi FWD | M9T 890/M9T 698/M9T 896/M9T 670/M9T 672/M9T 870/M9T 676 | 92 | 125 | 02.2010 | |
| RENAULT | Master III Van (FV) | 2.3 dCi FWD | M9T 696/M9T 698/M9T 680/M9T 678/M9T 896/M9T 694 | 107 | 146 | 02.2010 | |
| RENAULT | Master III Van (FV) | 2.3 dCi FWD | M9T 880/M9T 898 | 110 | 150 | 03.2013 | |
| RENAULT | Master III Van (FV) | 2.3 dCi FWD | M9T 890/M9T 670/M9T 672/M9T 870/M9T 676 | 74 | 101 | 02.2010 | |

Camshaft position sensor





Sensor de árbol de levas

Capteur de position d'arbre de came

Nockenwellenpositionssensor



| OEM | Part Number / FAE |
|-------|-------------------|
| VOLVO | 21123875 |
| VOLVO | 8658726 |
| | |
| | |
| | |
| | |
| | |
| | |
| | |

|  | | |  | |  | |  | |
|--|------------------|------------|---|-----|---|---------|---|--|
| VOLVO | C30 | D3 | D 5204 T5 | 110 | 150 | 10.2010 | 12.2012 | |
| VOLVO | C30 | D4 | D 5204 T | 130 | 177 | 10.2010 | 12.2012 | |
| VOLVO | C30 | D5 | D 5244 T9 | 120 | 163 | 10.2006 | 12.2012 | |
| VOLVO | C30 | D5 | D 5244 T8/D 5244 T13 | 132 | 180 | 10.2006 | 12.2012 | |
| VOLVO | C70 II Cabriolet | 2.4 D | D 5244 T9 | 120 | 163 | 03.2007 | 06.2013 | |
| VOLVO | C70 II Cabriolet | D3 | D 5204 T5 | 110 | 150 | 10.2010 | 06.2013 | |
| VOLVO | C70 II Cabriolet | D4 | D 5204 T | 130 | 177 | 10.2010 | 06.2013 | |
| VOLVO | C70 II Cabriolet | D5 | D 5244 T8/D 5244 T13 | 132 | 180 | 03.2006 | 06.2013 | |
| VOLVO | S40 II (MS) | 2.4 D5 | D 5244 T8/D 5244 T13 | 132 | 179 | 03.2006 | 12.2010 | |
| VOLVO | S40 II (MS) | D3 | D 5204 T5 | 110 | 150 | 10.2010 | 12.2012 | |
| VOLVO | S40 II (MS) | D4 | D 5204 T | 130 | 177 | 10.2010 | 12.2012 | |
| VOLVO | S60 I | 2.4 D | D 5244 T5 | 120 | 163 | 07.2005 | 12.2009 | |
| VOLVO | S60 I | 2.4 D | D 5244 T7 | 93 | 126 | 03.2005 | 04.2010 | |
| VOLVO | S60 I | 2.4 D5 | D 5244 T4 | 136 | 185 | 03.2005 | 04.2010 | |
| VOLVO | S60 II | 2.4 D4 AWD | D 5244 T21 | 140 | 190 | 03.2015 | | |
| VOLVO | S60 II | D3 | D 5204 T2/D 5204 T3 | 120 | 163 | 04.2010 | 12.2014 | |

| Camshaft position sensor | Sensor de árbol de levas | Capteur de position d'arbre de came | Nockenwellenpositionssensor | | | | |
|--------------------------|--------------------------|-------------------------------------|-----------------------------|-----|-----|---------|---------|
| VOLVO | S60 II | D3 | D 5204 T7 | 100 | 136 | 05.2012 | 12.2015 |
| VOLVO | S60 II | D4 | D 5204 T3 | 120 | 163 | 04.2010 | 12.2014 |
| VOLVO | S60 II | D5 | D 5244 T10 | 151 | 205 | 04.2010 | 12.2011 |
| VOLVO | S60 II | D5 | D 5244 T15 | 169 | 230 | 04.2014 | 12.2015 |
| VOLVO | S60 II | D5 | D 5244 T15/D 5244 T11 | 158 | 215 | 04.2011 | 12.2015 |
| VOLVO | S60 II | D5 AWD | D 5244 T15/D 5244 T11 | 158 | 215 | 04.2011 | 12.2015 |
| VOLVO | S60 II | D5 AWD | D 5244 T15 | 169 | 230 | 04.2014 | 12.2015 |
| VOLVO | S60 II | D5 AWD | D 5244 T10 | 151 | 205 | 04.2010 | 12.2011 |
| VOLVO | S80 II (AS) | 2.4 D | D 5244 T14 | 129 | 175 | 01.2010 | 03.2011 |
| VOLVO | S80 II (AS) | 2.4 D | D 5244 T/D 5244 T5 | 120 | 163 | 03.2006 | |
| VOLVO | S80 II (AS) | D3 / D4 | D 5204 T2/D 5204 T3 | 120 | 163 | 01.2010 | |
| VOLVO | S80 II (AS) | D5 | D 5244 T15/D 5244 T11 | 158 | 215 | 06.2011 | |
| VOLVO | S80 II (AS) | D5 | D 5244 T4 | 136 | 185 | 03.2006 | |
| VOLVO | S80 II (AS) | D5 | D 5244 T10 | 151 | 205 | 01.2010 | |
| VOLVO | S80 II (AS) | D5 AWD | D 5244 T10 | 151 | 205 | 01.2010 | |
| VOLVO | S80 II (AS) | D5 AWD | D 5244 T15 | 158 | 215 | 06.2011 | |
| VOLVO | S80 II (AS) | D5 AWD | D 5244 T4 | 136 | 185 | 01.2007 | |
| VOLVO | V40 Fastback | D3 | D 5204 T6 | 110 | 150 | 03.2012 | 03.2015 |
| VOLVO | V40 Fastback | D4 | D 5204 T4 | 130 | 177 | 03.2012 | |
| VOLVO | V40 Fastback | T4 | B 5204 T8 | 132 | 180 | 07.2013 | |
| VOLVO | V40 Fastback | T4 AWD | B 5204 T8 | 132 | 180 | 07.2013 | |
| VOLVO | V50 (MW) | 2.4 D5 | D 5244 T8/D 5244 T13 | 132 | 179 | 03.2006 | 12.2010 |
| VOLVO | V50 (MW) | 2.4 Tdi | D 5244 T9 | 120 | 163 | 05.2007 | 12.2010 |
| VOLVO | V50 (MW) | D3 | D 5204 T5 | 110 | 150 | 10.2010 | 12.2012 |
| VOLVO | V50 (MW) | D4 | D 5204 T | 130 | 177 | 10.2010 | 12.2012 |
| VOLVO | V60 | 2.4 D5 | D 5244 T15/D 5244 T11 | 158 | 215 | 04.2011 | 12.2015 |
| VOLVO | V60 | 2.4 D5 AWD | D 5244 T15/D 5244 T11 | 158 | 215 | 04.2011 | 12.2015 |
| VOLVO | V60 | 2.4 D5 Hybrid AWD | D87PHEV | 120 | 163 | 03.2015 | |
| VOLVO | V60 | 2.4 Hybrid AWD | D82PHEV/D 5244 T15 | 158 | 215 | 06.2012 | 12.2015 |
| VOLVO | V60 | D3 | D 5204 T7 | 100 | 136 | 05.2012 | 12.2015 |
| VOLVO | V60 | D3 / D4 | D 5204 T2/D 5204 T3 | 120 | 163 | 07.2010 | 12.2014 |
| VOLVO | V60 | D4 AWD | D 5244 T12 | 133 | 181 | 10.2013 | 12.2015 |
| VOLVO | V60 | D4 AWD | D 5244 T21 | 140 | 190 | 03.2015 | |
| VOLVO | V60 | D4 AWD | D 5244 T17 | 120 | 163 | 05.2012 | |
| VOLVO | V60 | D5 | D 5244 T10 | 151 | 205 | 07.2010 | 12.2011 |

| Camshaft position sensor | Sensor de árbol de levas | Capteur de position d'arbre de came | Nockenwellenpositionssensor | | | | |
|--------------------------|--------------------------|-------------------------------------|---------------------------------|-----|-----|---------|---------|
| VOLVO | V60 | D5 | D 5244 T23 | 169 | 230 | 04.2014 | 12.2015 |
| VOLVO | V60 | D5 AWD | D 5244 T23/D 5244 T15 | 169 | 230 | 04.2014 | 12.2015 |
| VOLVO | V60 | D5 AWD | D 5244 T10 | 151 | 205 | 07.2010 | 12.2011 |
| VOLVO | V60 | D6 Hybrid AWD | D97PHEV | 162 | 220 | 03.2015 | |
| VOLVO | V70 II (SW) | 2.4 D | D 5244 T7 | 93 | 126 | 04.2005 | 12.2008 |
| VOLVO | V70 II (SW) | 2.4 D5 | D 5244 T4 | 136 | 185 | 04.2005 | 12.2008 |
| VOLVO | V70 II (SW) | 2.4 D5 | D 5244 T/D 5244 T5 | 120 | 163 | 01.2001 | 12.2008 |
| VOLVO | V70 II (SW) | 2.4 D5 AWD | D 5244 T4 | 136 | 185 | 05.2005 | 08.2007 |
| VOLVO | V70 III (BW) | 2.4 D | D 5244 T14 | 129 | 175 | 04.2009 | 12.2010 |
| VOLVO | V70 III (BW) | 2.4 D | D 5244 T5 | 120 | 163 | 04.2007 | 12.2010 |
| VOLVO | V70 III (BW) | D3 | D 5204 T7 | 100 | 136 | 10.2007 | 12.2015 |
| VOLVO | V70 III (BW) | D3 / D4 | D 5204 T2/D 5204 T3 | 120 | 163 | 03.2010 | 12.2015 |
| VOLVO | V70 III (BW) | D4 AWD | D 5244 T17 | 120 | 163 | 10.2007 | 12.2015 |
| VOLVO | V70 III (BW) | D4 AWD | D 5244 T12 | 133 | 181 | 10.2013 | |
| VOLVO | V70 III (BW) | D5 | D 5244 T10 | 151 | 205 | 10.2008 | 12.2011 |
| VOLVO | V70 III (BW) | D5 | D 5244 T4 | 136 | 185 | 04.2007 | 12.2009 |
| VOLVO | V70 III (BW) | D5 | D 5244 T15/D 5244 T11 | 158 | 215 | 04.2011 | 12.2015 |
| VOLVO | V70 III (BW) | D5 AWD | D 5244 T4 | 136 | 185 | 04.2007 | 12.2009 |
| VOLVO | V70 III (BW) | D5 AWD | D 5244 T10 | 151 | 205 | 12.2009 | 12.2011 |
| VOLVO | V70 III (BW) | D5 AWD | D 5244 T15/D 5244 T11 | 158 | 215 | 04.2011 | 12.2015 |
| VOLVO | XC60 | 2.4 D | D 5244 T14 | 129 | 175 | 04.2009 | 12.2010 |
| VOLVO | XC60 | 2.4 D / D3 / D4 AWD | D 5244 T16/D 5244 T5/D 5244 T17 | 120 | 163 | 05.2008 | 02.2017 |
| VOLVO | XC60 | D3 | D 5204 T7 | 100 | 136 | 04.2012 | 12.2015 |
| VOLVO | XC60 | D3 / D4 | D 5204 T2/D 5204 T3 | 120 | 163 | 03.2010 | 12.2014 |
| VOLVO | XC60 | D4 AWD | D 5244 T21 | 140 | 190 | 03.2015 | 02.2017 |
| VOLVO | XC60 | D4 AWD | D 5244 T12 | 133 | 181 | 10.2013 | 12.2015 |
| VOLVO | XC60 | D5 | D 5244 T11/D 5244 T15 | 158 | 215 | 06.2011 | 02.2017 |
| VOLVO | XC60 | D5 AWD | D 5244 T23 | 169 | 230 | 04.2014 | 12.2015 |
| VOLVO | XC60 | D5 AWD | D 5244 T4 | 136 | 185 | 05.2008 | 12.2009 |
| VOLVO | XC60 | D5 AWD | D 5244 T10 | 151 | 205 | 07.2009 | 06.2011 |
| VOLVO | XC60 | D5 AWD | D 5244 T15/D 5244 T11 | 158 | 215 | 04.2011 | 12.2015 |
| VOLVO | XC60 | D5 AWD | D 5244 T22/D 5244 T20 | 162 | 220 | 03.2015 | 02.2017 |
| VOLVO | XC70 Cross Country | 2.4 D5 AWD | D 5244 T4 | 136 | 185 | 12.2005 | 08.2007 |
| VOLVO | XC70 Cross Country | 2.4 D5 XC AWD | D 5244 T | 120 | 163 | 09.2002 | 08.2007 |
| VOLVO | XC70 II | 2.4 D | D 5244 T14 | 129 | 175 | 06.2009 | 12.2010 |

| Camshaft position sensor | Sensor de árbol de levas | Capteur de position d'arbre de came | Nockenwellenpositionssensor | | | | |
|--------------------------|--------------------------|-------------------------------------|---------------------------------|-----|-----|---------|---------|
| VOLVO | XC70 II | 2.4 D / D4 AWD | D 5244 T16/D 5244 T5/D 5244 T17 | 120 | 163 | 08.2007 | |
| VOLVO | XC70 II | D3 | D 5204 T2/D 5204 T3 | 120 | 163 | 04.2010 | 12.2015 |
| VOLVO | XC70 II | D4 AWD | D 5244 T12 | 133 | 181 | 10.2013 | |
| VOLVO | XC70 II | D5 AWD | D 5244 T10 | 151 | 205 | 04.2009 | 12.2011 |
| VOLVO | XC70 II | D5 AWD | D 5244 T15/D 5244 T11 | 158 | 215 | 04.2011 | 12.2015 |
| VOLVO | XC70 II | D5 AWD | D 5244 T4 | 136 | 185 | 04.2007 | 12.2009 |
| VOLVO | XC70 II | D5 AWD | D 5244 T20 | 162 | 220 | 03.2015 | |
| VOLVO | XC90 I (275) | D3 / D5 | D 5244 T5 | 120 | 163 | 04.2009 | 12.2014 |
| VOLVO | XC90 I (275) | D5 | D 5244 T4 | 136 | 185 | 04.2005 | 12.2010 |
| VOLVO | XC90 I (275) | D5 AWD | D 5244 T18 | 147 | 200 | 01.2011 | 12.2014 |
| VOLVO | XC90 I (275) | D5 AWD | D 5244 T5 | 120 | 163 | 10.2007 | 12.2010 |